



MARCHAND

DOORS · WINDOWS
mixed woodwork

C A T A L O G U E



MARCHAND

Choosing an ELEGANCE main front door is an absolute certainty of offering your home a unique signature.

It is making the choice of noble and modern materials, combine with animated content and decorative effects, around a subtle balance between glass and panels created in complicity by a Designer with a long history with our Company, the ELEGANCE door offers a new perspective of design and creativity across models playing with a variety of materials, reflections and colors...

Created to answer your requirements for security, insulation, comfort and design, our entrance doors fulfill creativity with architectural shapes whether contemporary or traditional.

Our doors take full part in enhancing your home and the expression of your style of living.

As you open this catalogue allow yourself to be seduced with innovation.

QUALITY

A performing product is a result of past experience, evokes tradition and audacity of creation. For over 50 years, technology, imagination and competence have been at the heart of preoccupation at Marchand.

CUSTOM

New or existing homes, Entreprises Marchand will suggest solutions either in standard or custom dimensions representing over half our sales, custom dimensions are possible in all styles.

FREEDOM OF CHOICE

Choice of material, choice of lines, choice of colors and choice of models, all choices are in Marchand's range.

- Straight or curved
- Interior painted or stained
- Solid panels or glass
- Hinged or sliding doors

Main front or garden doors and also garage doors answer to all these questions in this catalogue.

WOOD

We offer cherry, oak, mahogany, wild cherry and walnut.

Finishing: Varnished or painted, rigorous and dependable application



MARCHAND

CHARM AND ELEGANCE TO YOUR HOME

ARCHED TOP DOUBLE DOORS



Model: ARCHED V1-1

ELEGANCE

BENDING OF ALUMINIUM

Highly qualified in bending shaped aluminium without losing details, Marchand apply their know-how to create any possible shapes.

Taking charge of complementary operations; such as covering wood, interior finishing, lacquer or paint

Interior view



Model: ARCHED V1-1



MARCHAND

NOTCHED DOUBLE DOOR



ELEGANCE

With this collection, glass blends well with the exterior and interior environment. Available in multiple of shapes, it reflects the exterior and lets you appreciate the contour and forms. Such thin aluminium frames allow maximum luminosity which disappear to allow the most view. On the interior sublime refined wood gives your door an incomparable elegance.

Interior view



Model: V1-1 NOTCHED / LOCK



MARCHAND

UNRESTRICTED VIEW TO THE GARDEN

DOUBLE GARDEN DOOR



GARDEN / TERRACE

Today the ELEGANCE garden door has inherit all the assets by integrating the most recent evolutions :

- Massive structure reduced for maximum lighting
- Numerous options comfort, insulation and decoration to adapt to your style.

Interior view



Multi-lock



Model: TERRACE DOUBLE DOOR



MARCHAND

EXQUISITELY DETAILED



ORGANIC GLAZING

ELEGANCE

Organic glazing translucent white thermo lacquered facing the exterior only.

Option: Brushed inox grills

Interior view



Model: DOUBLE DOOR V1-1 / GLASS THERMOFORMED



MARCHAND

GREET THE WORLD WITH STYLE

COMPLETE CLASSIC CHARM



ELEGANCE

Faithful to your taste, the ELEGANCE doors display a standing with raised panels. This collection with traditional style doors will give all the nobleness and character to your home.

Interior view

Impeccable wood



Model: 11-51 « VERSAILLES » PANELS



MARCHAND

UNRIVALED PERFORMANCE

THE COMPLEMENTARY ELEMENTS



ELEGANCE

In combining complementary elements, transom, filler, lateral windows, we can adapt to all architectural situations.





MARCHAND

FROM TRENDY TO TIMELESS

MODERN STYLE AT YOUR REACH



MODERN

The first look is essential upon selecting the main entrance door. Marchand has selected materials, shapes and colors to suggest creative modern doors.

Interior view



Model: 1-1 MODERN FRAME

INNOVATION /

MANUFACTURING

STEP A : Pre-treating the surface of the door or window to be ready for painting.



STEP B : Molding the fiberglass to shape the door or window. Resin-covered fiberglass. The physical and mechanical properties of fiberglass are excellent due to low thermal conductivity, resistance to mildew, corrosion, dimensional stability under various temperatures and life span.



STEP C: Cutting of doors or windows.



THE COLORS



THE COLORS GIVES ELEGANCE!

We are proud to offer you a high-performance architectural finish, available in 189 stock colors, and the possibility of any custom-match color : it is the powder coating process.

Specifically formulated for use on architectural aluminum components, and offering you a high quality finish with outstanding weatherability, it is the only finishing technology 100% environmentally-friendly.

Our seven-stage pretreatment of the surfaces, each step meticulously monitored, offers you a quality that has already passed the test of time. The process is offered in two high-performance series that meet the requirement of the world's most demanding architectural specifications.



MARCHAND

ENTRANCE DOOR, HARMONIZE YOUR FACADE

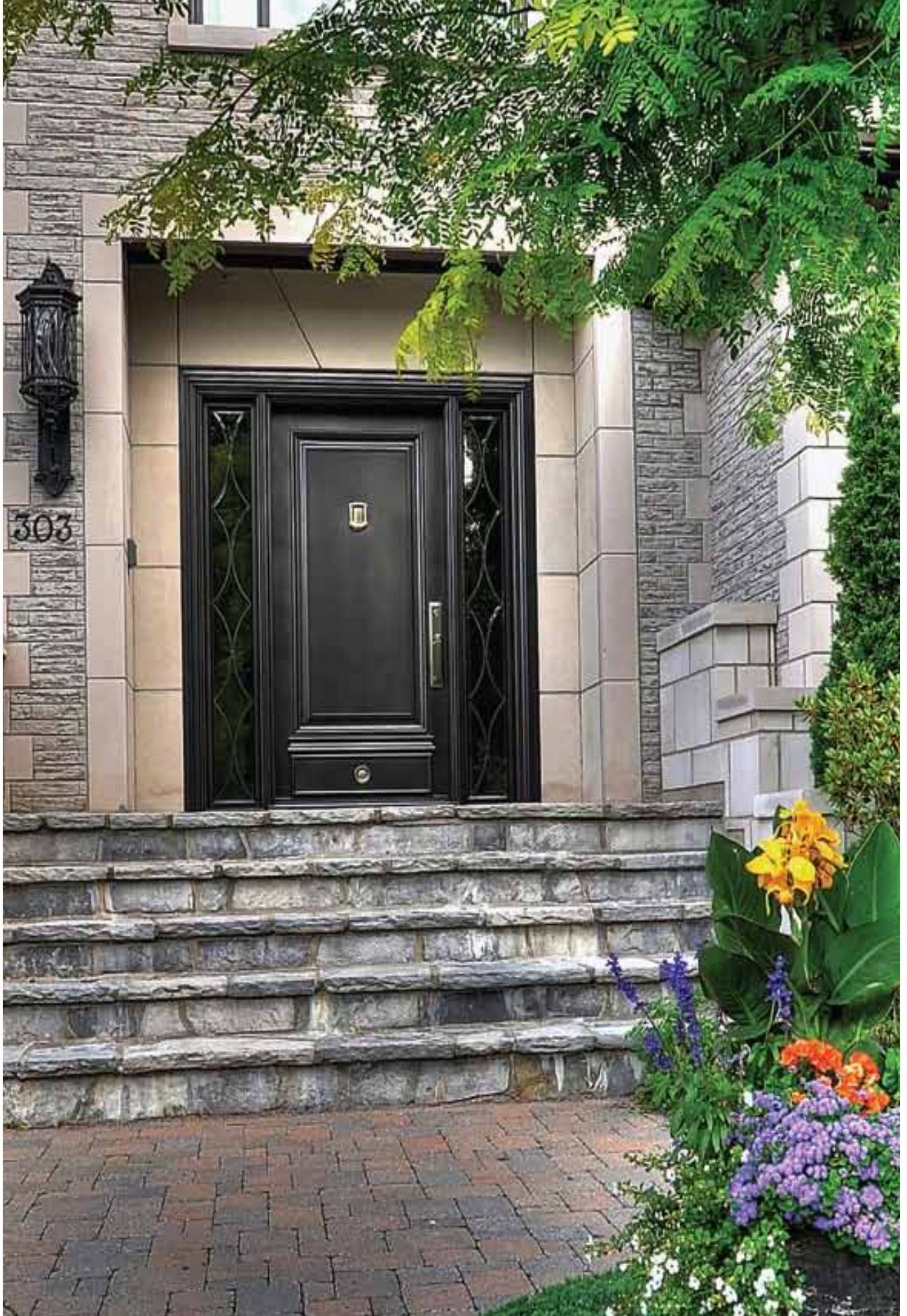

ELEGANCE

The fix lateral windows offer many choices.
Ideal for increasing the width of an entrance door, and luminosity.

Interior view



Model: 11-51 / « VERSAILLES » PANELS



VARIOUS SIDELIGHT OPTIONS

SIDELIGHTS

Sidelight standard dimensions (with base)

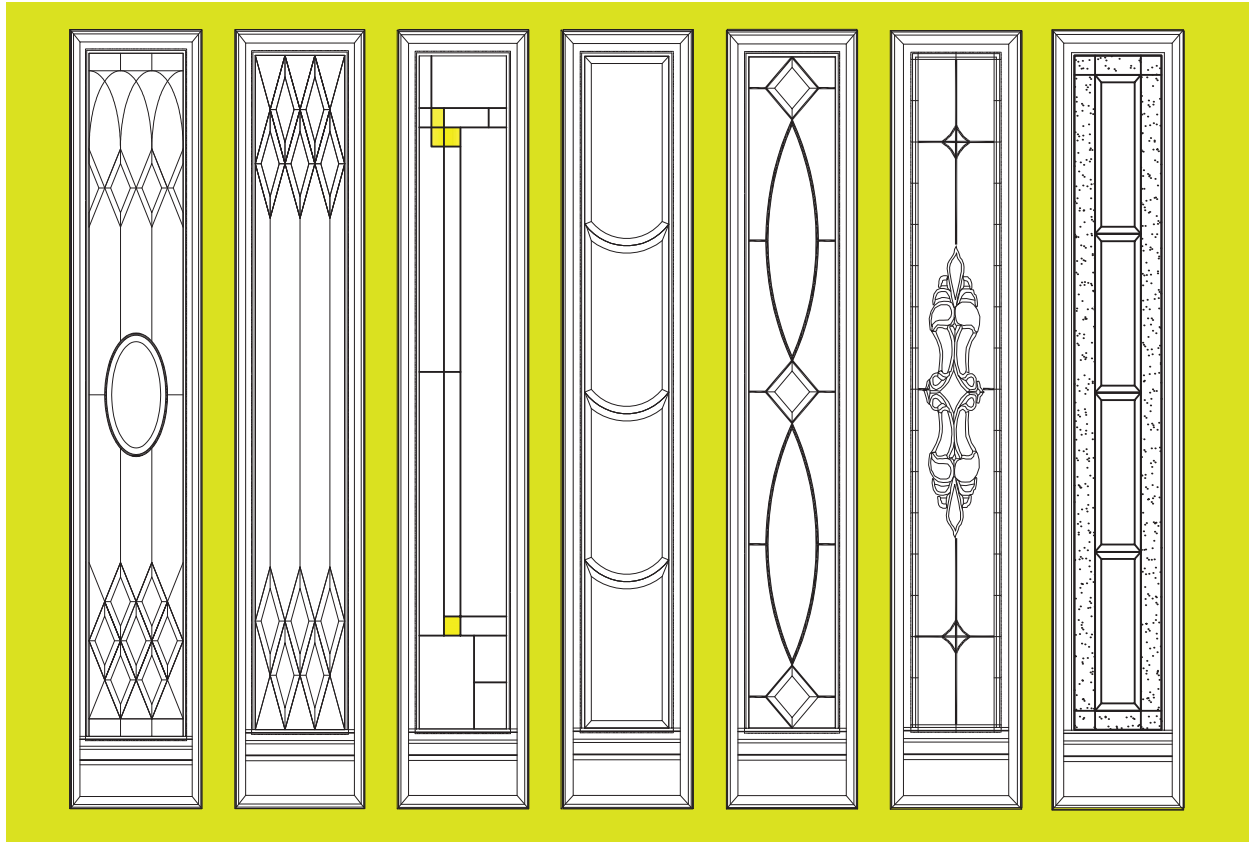

Sidelight standard dimensions (without base)

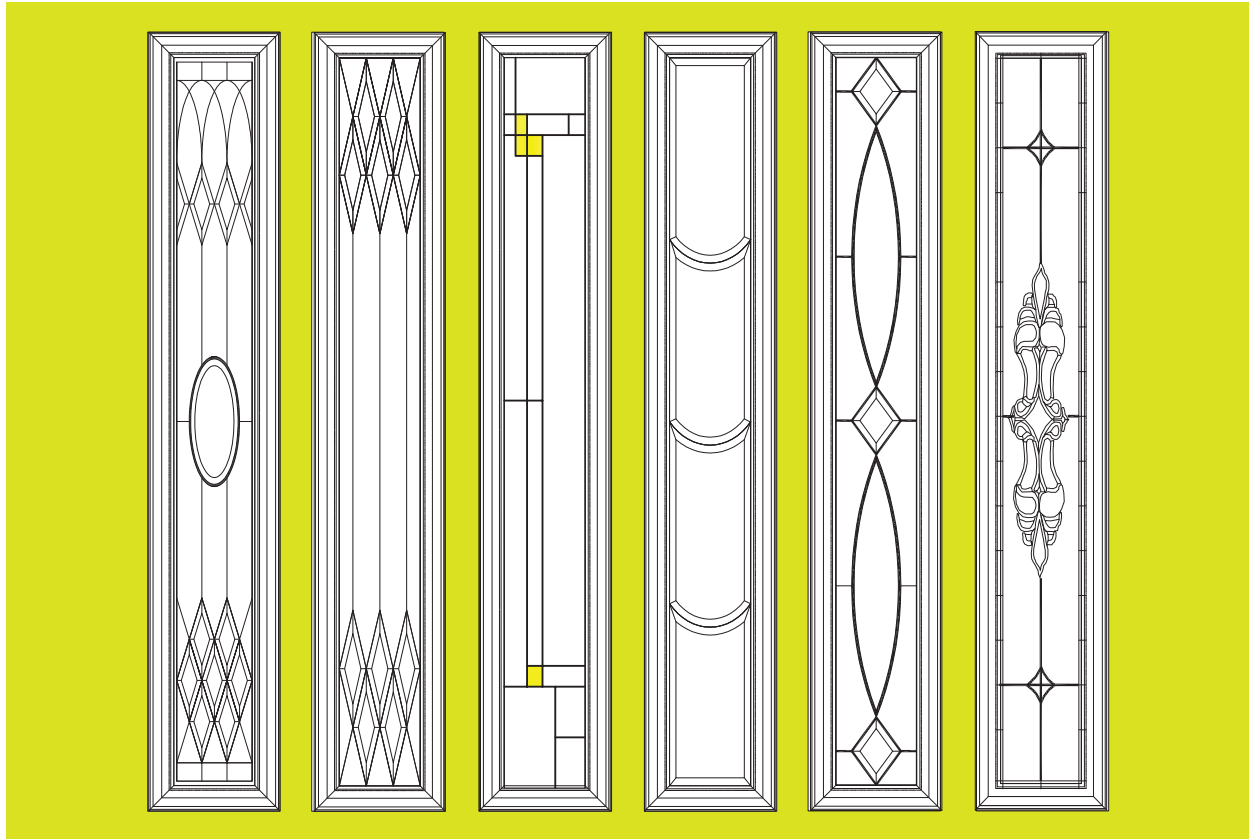



VARIOUS SIDELIGHT OPTIONS

Standard dimensions
Sidelights with base

Standard dimensions
Sidelight without base

High

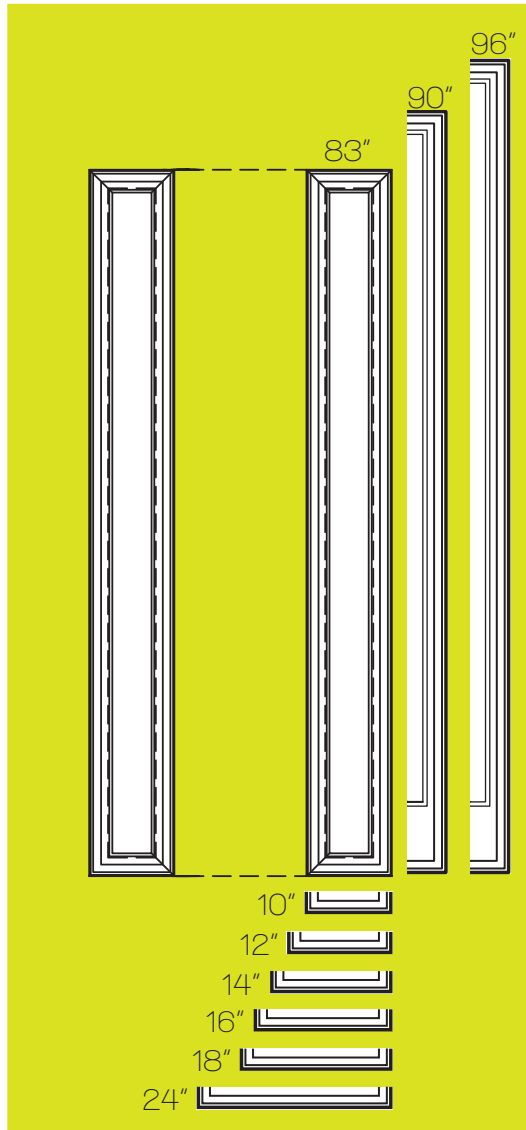
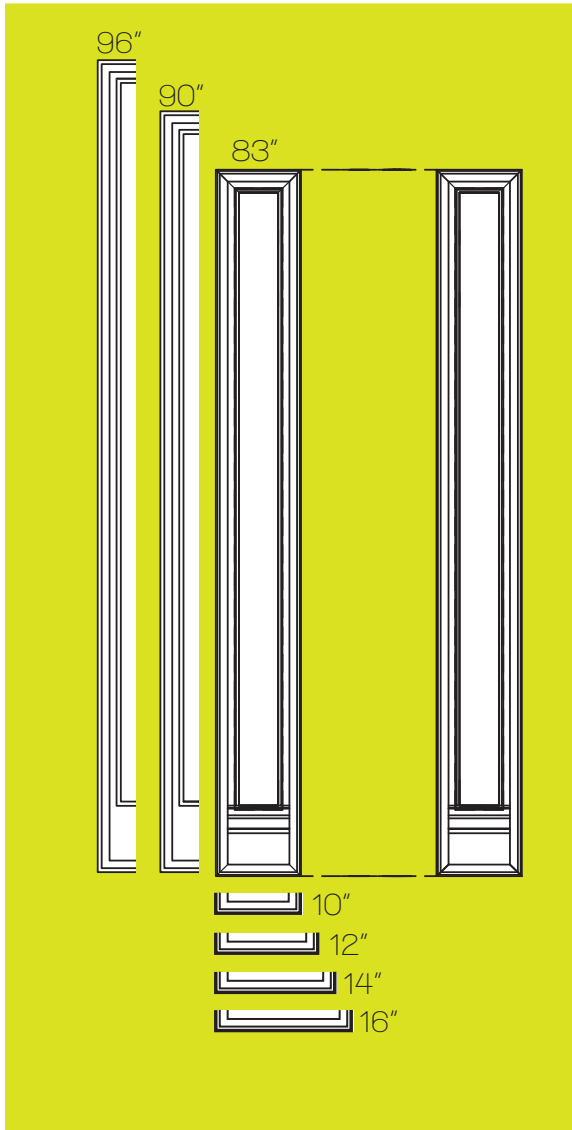

SIDELIGHTS

Width

Glass sidelights allow natural daylight in your vestibule. They can be complete glass or partly glass.

The glass can be subdivided with lead or muntin bars fix or removable. The use of tempered glass adds security.

They can be double or triple panel fill with argon gas to meet with energy requirements.



MARCHAND

UNRIVALED PERFORMANCE



CHARM IN CLASSIC

ELEGANCE

Faithful to your taste, the ELEGANCE doors display a standing with affirmative raised design. This collection with traditional style doors will give all the nobleness and character to your home.

Interior view

Impeccable wood



Model : 111-115



MARCHAND

EXQUISITELY DETAILED

SIMPLE LINES AND RIGOROUS CONCEPTION



ELEGANCE

Solid panels or glass, arched or straight, the ELEGANCE door meets you needs.



Interior view

Model: V1-ARCHED + TRANSFORMED GLASS





MARCHAND

THE MATERIAL SUBMITS TO ALL DESIGNS



MODERN

Allow yourself to be seduced by modern contemporary collection. This collection with refine lines works with shapes between aluminium, glass and wood, it confirms your desire towards modernity.

Interior view



Model: V1-1



MARCHAND

PROVIDE A WARM WELCOME

ILLUMINATE YOUR ENTRANCE WITH LARGE GLASS

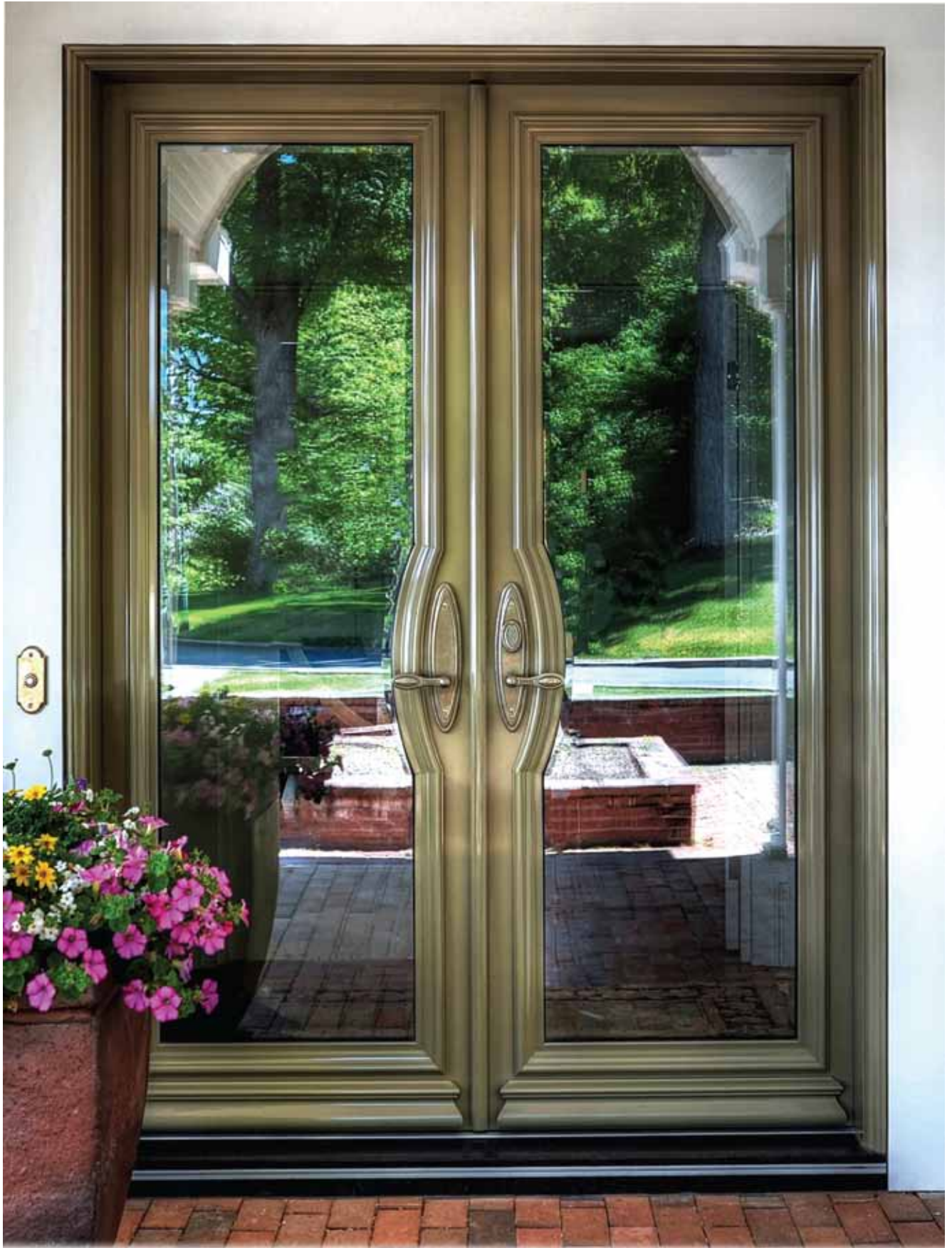

ELEGANCE

Complete luminosity, soft and rounded frames maintaining your privacy while offering daylight.

Interior view



Model: V1-1 WITH CURVED OUTLINES



MARCHAND

PROVIDE A WARM WELCOME

AN ENTRANCE, A STYLE, A DESIRE



ELEGANCE

THE ADDITIONAL ELEMENTS



By combining the elements complementary, transom, sidelight, you can customize remarkably your home.



MARCHAND

INTRODUCING SHAPES

SINGLE DOOR WITH TRANSOM



ELEGANCE

SOLID OR GLASS TRANSOM

Transoms allow for a higher main front door and add more light in the interior also more architectural personality on the exterior.

Interior view



Model: 1-1 WITH TRANSOM AND EQUAL SIDELITES

QUALITY /

STYLE

100% ÉLÉGANCE DESIGN

The creation of a new ELEGANCE door with exclusive design, soft shapes and curves or on the contrary fine lines and very contemporary. The ELEGANCE doors offer a signature of aesthetic unique exterior and interior.

NOBLE AND MODERN LINES

The refine straight lines or traditional door handles renew the personality of your entrance door. They combine strength and finesse leaving light shine on their surface guiding the look on their optimal proportions. It is a complete integration of all accessories and assemblies for the ELEGANCE door which brings unrivaled quality.

QUALITY IN THE SLIGHTEST DETAILS

Enjoy innovation with the ELEGANCE front door.

The new technology of automated parameterize in one gesture without tools, it eliminates any risk of mistakes, our CNC machinery adjusts to a millimeter.

The new door handles are treated with PVD surface, guaranteed 20 years, total handle comfort and assured quality finish.

INNOVATION /

MONOBLOC

THERMAL INSULATION

Because insulation improved directly your interior comfort, the ELEGANCE doors are fully equipped with superior insulating technology. An open cast in one piece 57 mm including a fiberglass structure insulated with high density urethane. The glass doors can have triple pane for a better and higher thermal performance.

SECURITY

For maximum security the ELEGANCE doors are equipped with performing secure device: mechanism with 3 locks and one piece structure 197mm with maximum thickness. Our "garden" and "terrace" doors all have tempered glass retarding break in.

DURABLE AND EASY MAINTENANCE

The quality and sturdiness of aluminium give the ELEGANCE door a resistance which is important on the exterior and a high durability mechanical performance. Easy maintenance, simple clear water is sufficient. The wood interior receives 5 coats of finishing high resistance



MARCHAND

GREET THE WORLD WITH STYLE

RESPECTING THE CHARACTER OF YOUR HOME



ÉLÉGANCE

Exclusive glazing, specially designed for your entrance door by designer Ross, will seduce you.

Original colors, transformed glass, classic style...

Give more character to your facade and warmth in your vestibule.

Interior view



Model: V11-51





MARCHAND

DOORS WITH ONLY GOOD PERFORMANCE



ARCHED

INTERIOR SIDE, PERFORMANCE AND ELEGANT WOOD

- Warm atmosphere
- Natural beauty of noble material
- Excellent thermal insulation
- Stable and easy maintenance

Interior view



Model V1-1 CURVED



MARCHAND

DOUBLE DOORS ARE UNIQUE



DOUBLE

- Guaranteed results with the aesthetic of your façade
- Preferred formula for wide openings
- It also can be embellish with a transom





MARCHAND

GREAT SOURCE OF NATURAL LIGHT

THE LIFT AND SLIDE DOOR



ELEGANCE

The ELEGANCE lift and slide door system best fits your needs for security and durability.

The high level of technical combination emerges with an innovative system.

The Lift and Slide door is equipped with a permanent threshold allowing a passage without collision with ease between the interior and the exterior.

Interior view



Model : LIFT AND SLIDE





MARCHAND

ELEGANT CUSTOM DESIGN

THE "VERSAILLES" GARAGE DOOR



LOW MAINTENANCE, SOLID, INSULATING

Maintenance free: can be cleaned with a simple stroke of a sponge. Resistant: high quality thermo lacquering guarantees an exceptional longevity. Energy saving: panels with thermal break and double weatherstrip with polyurethane core injected without CFC giving a high thermal insulation.

Marchand offers complete latitude in design with garage doors in dimensions and style which will harmonize perfectly to your home whether contemporary or modern.

VERSAILLES



Inspired by the aesthetic of the ELEGANCE door, the garage door is rigorously built by Marchand.



MARCHAND

CUSTOM DESIGN TO COMPLEMENT YOUR HOME'S ARCHITECTURE

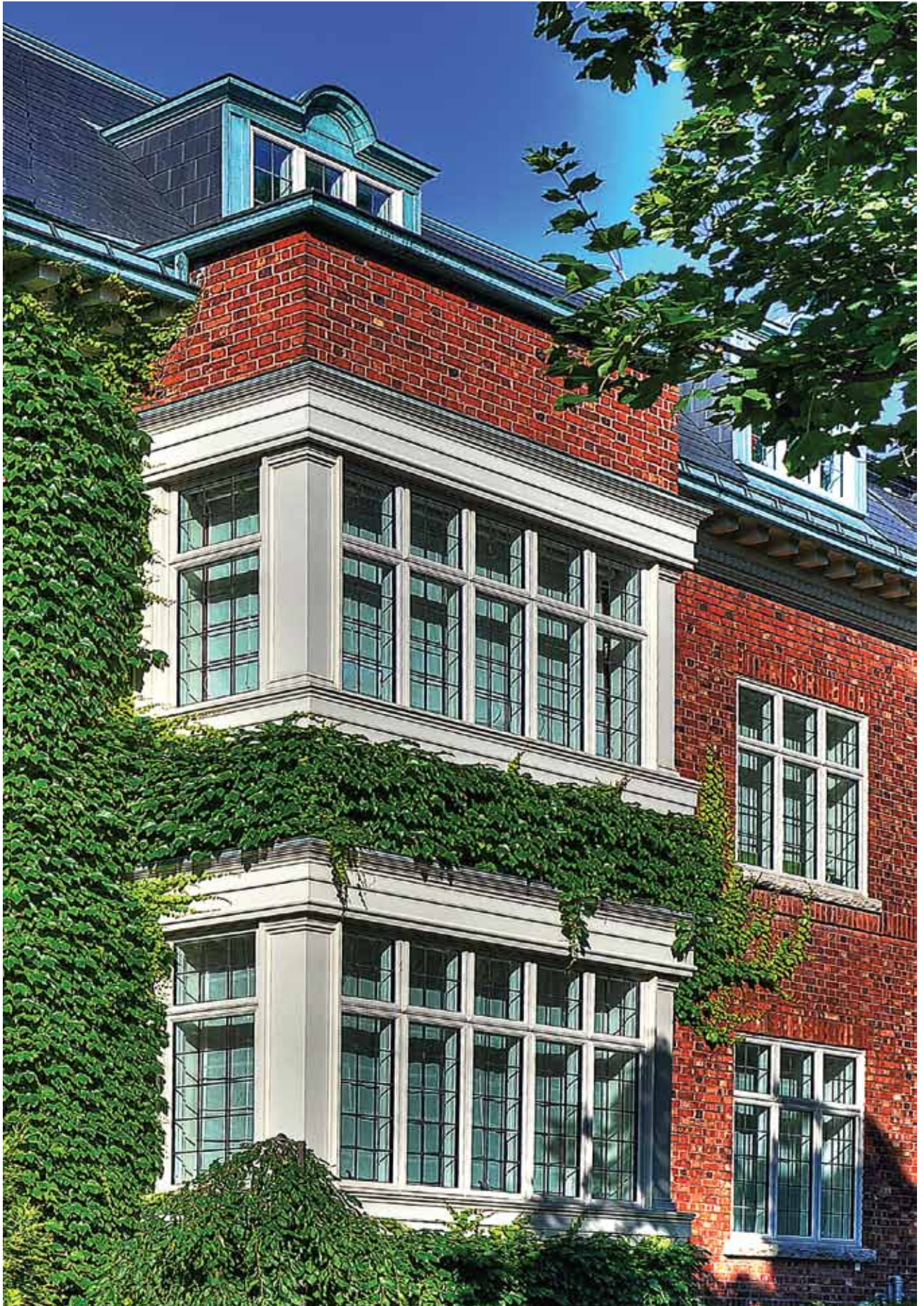

THE COVERINGS...

COVERINGS





MARCHAND

DOUBLE WINDOW-DOOR "CONCEPT II"

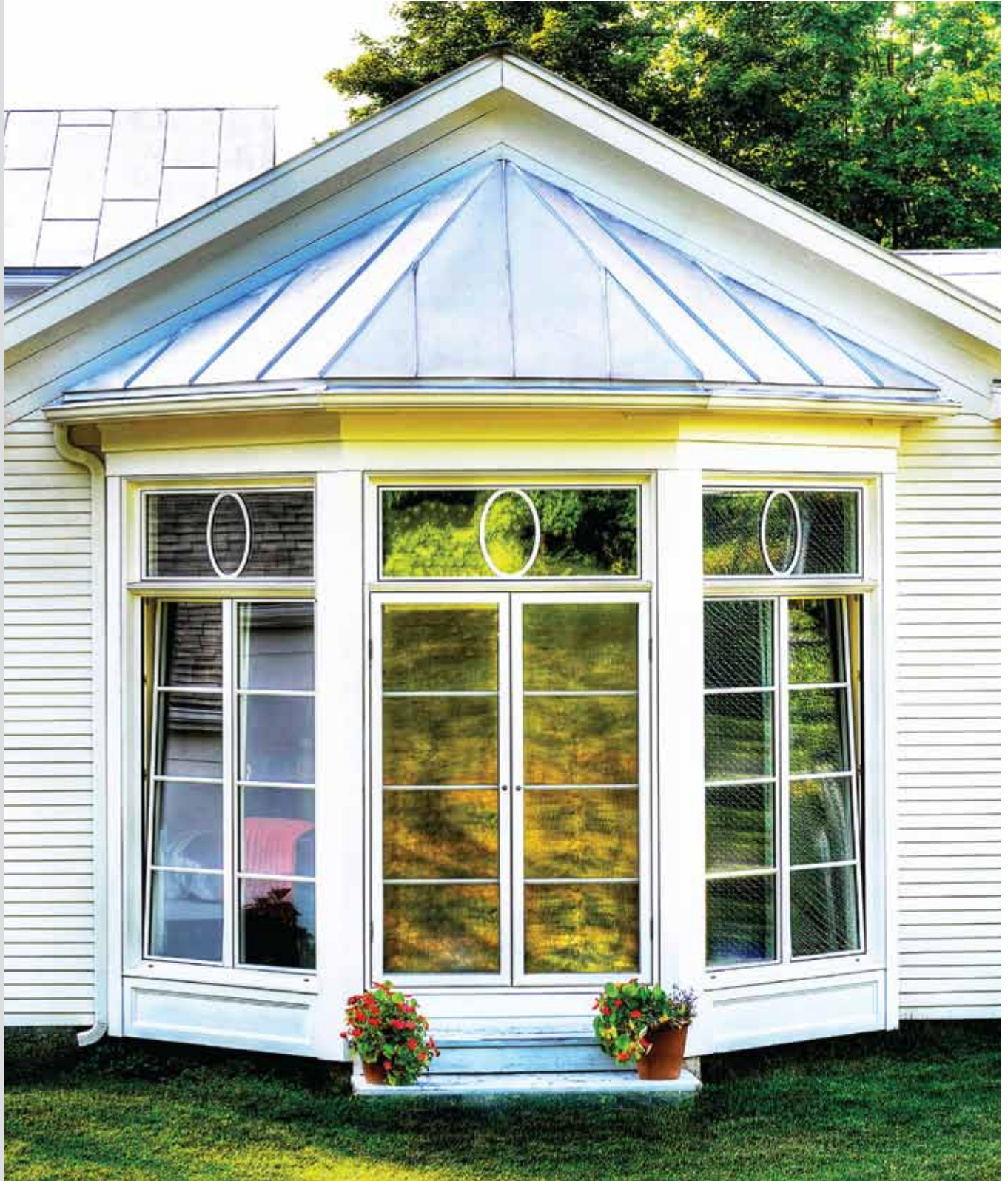

WINDOW-DOOR

Performing doors are an important part of any home.



Model : "Concept II"



MARCHAND

FROM TRENDY TO TIMELESS

REFINED MODERN DOOR



TRANSITIONAL



The ELEGANCE door is perfectly at the heart of current tendencies with fine lines.

The transitional style is a blend between traditional and contemporary, it is timeless.



SINGLE DOOR DIMENSIONS

Standard Dimensions (single door)

High

SINGLE DOOR

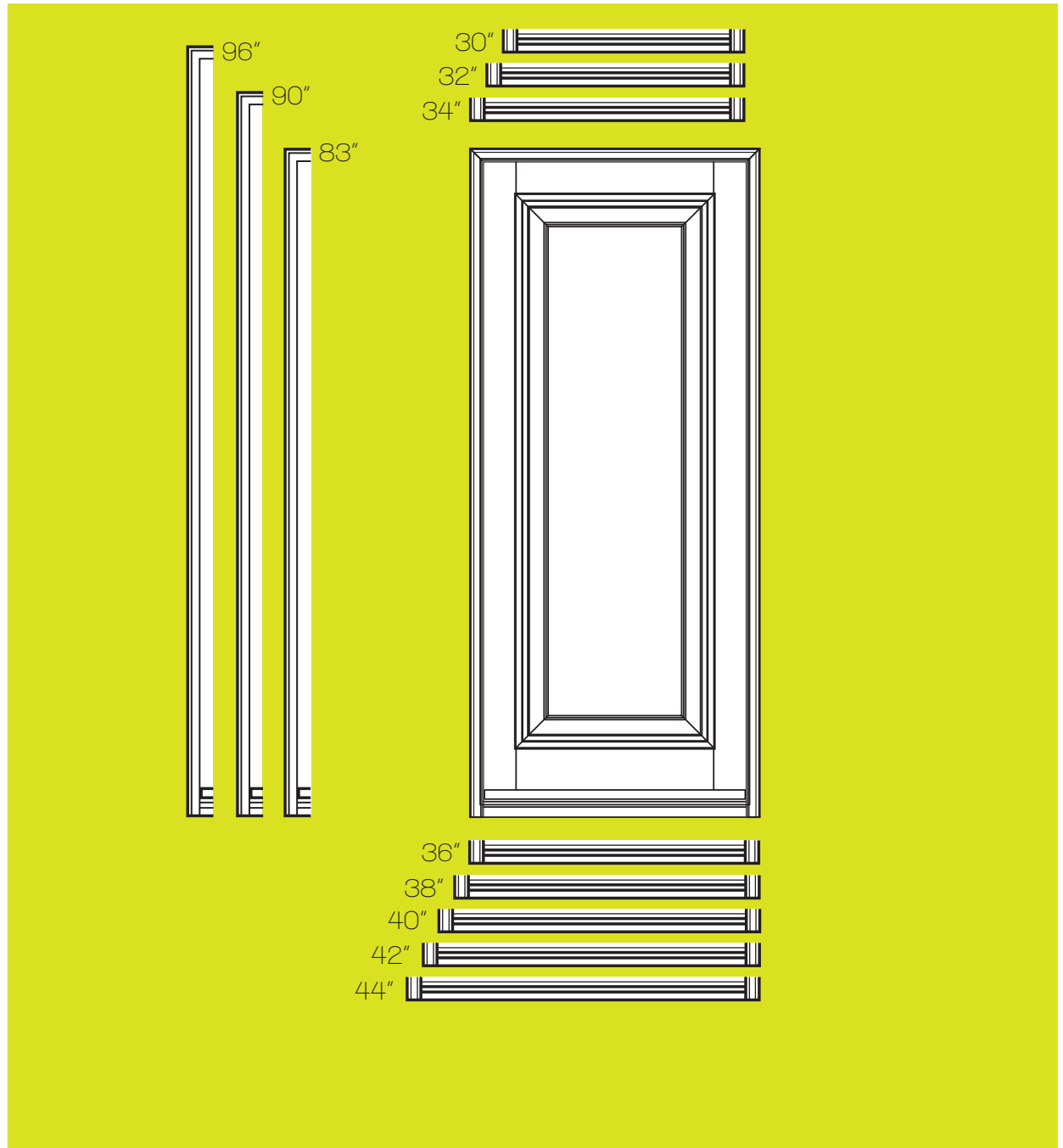

Width



DOUBLE DOOR DIMENSIONS

Standard dimensions (double door)

High

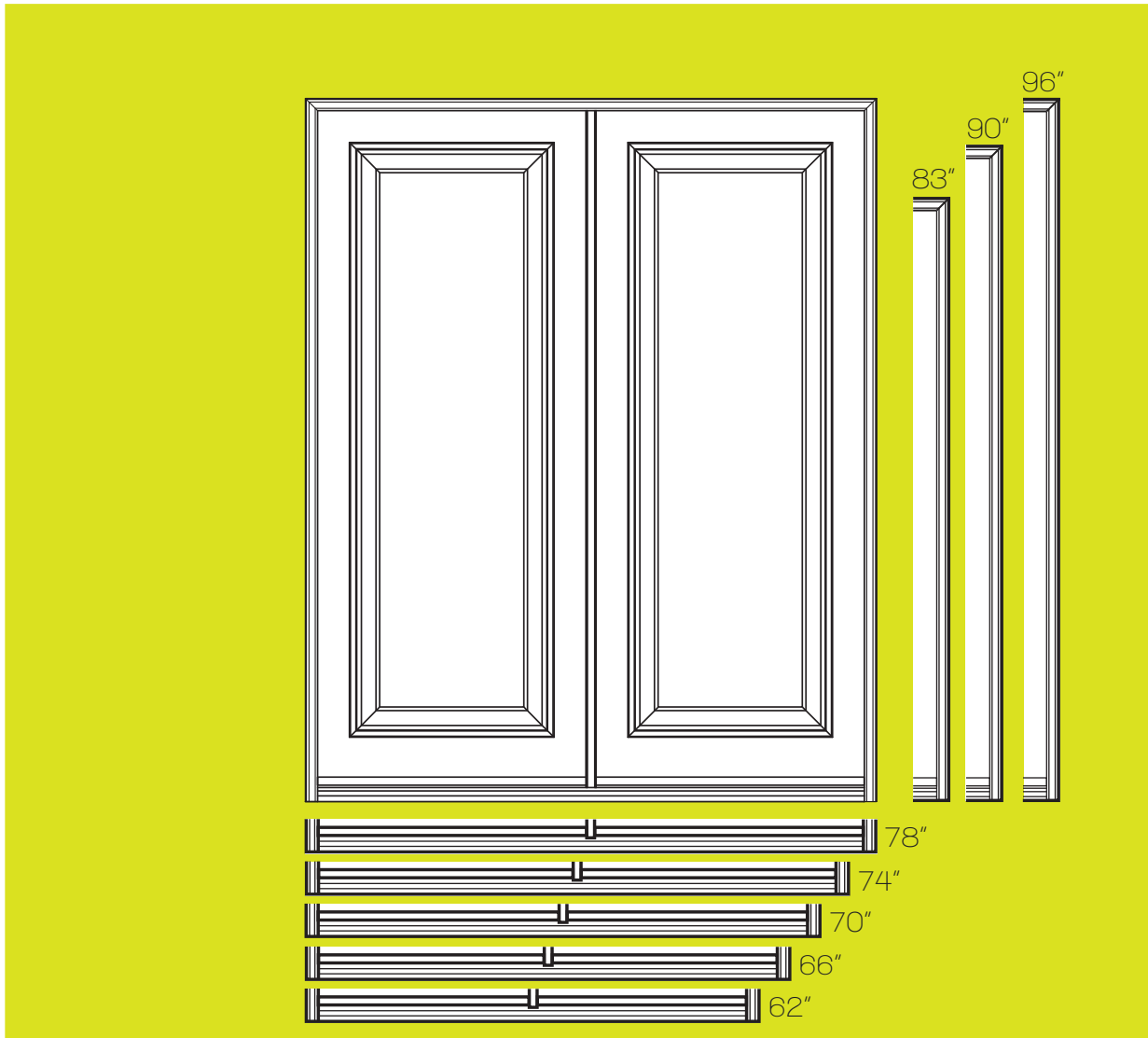

Width

The ELEGANCE double door are supplied with a detailed astragal.

The astragal is a vertical attached to the dormant door making for a firm fastening. It also provides water and wind resistance. An unlocking mechanism allows both doors to open.

DOUBLE DOOR



VARIOUS GRILLS OPTIONS

GRILLS



Artistic embellishing grilles, classical, old fashion or contemporary with specific design.



VARIOUS GRILLS OPTIONS

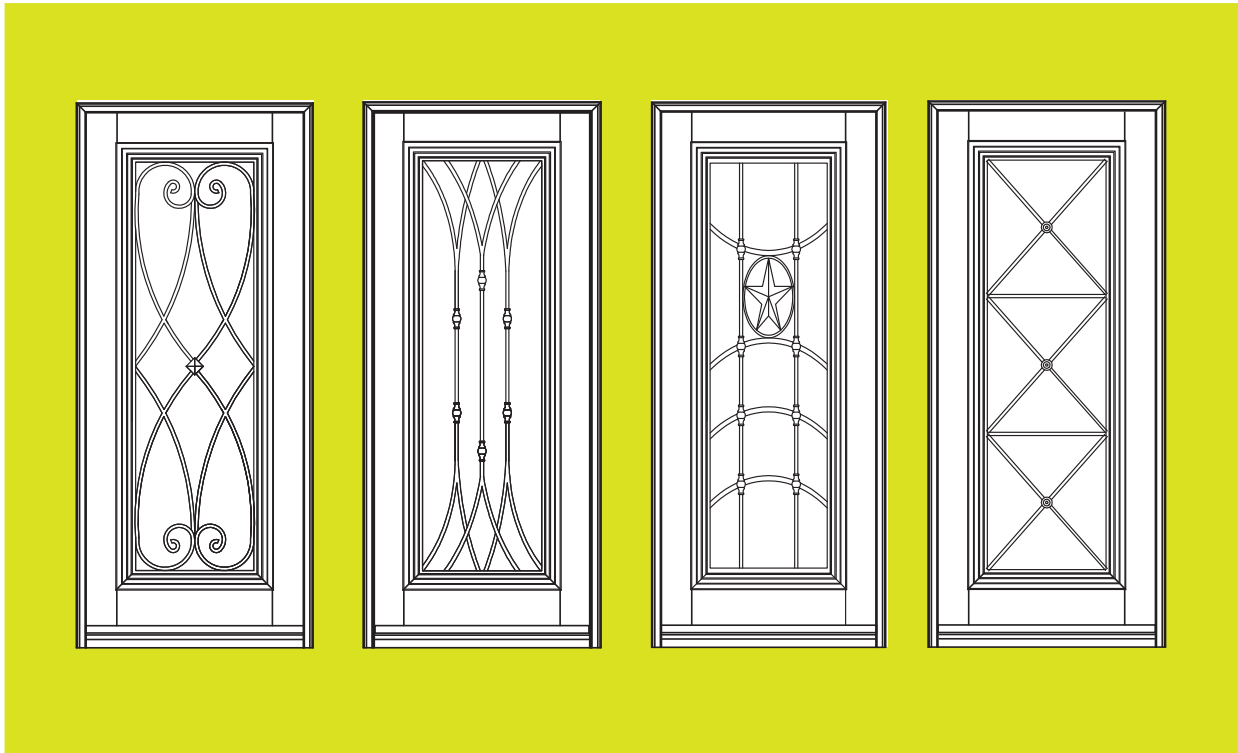

GRILLS

Made of aluminium or steel with baked powder paint finish, resistant to all weather conditions, wire grilles by Marchand are maintenance free.



NUMEROUS MOLDING OPTIONS

Solid panels can be substituted with glass.

MODELS

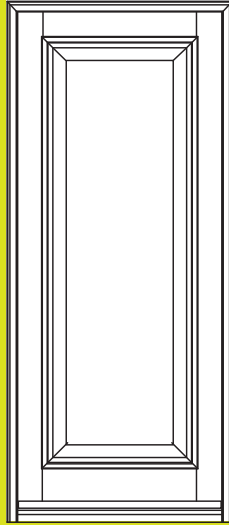

DOOR WITH PANEL
TYPE "A" MOLDING

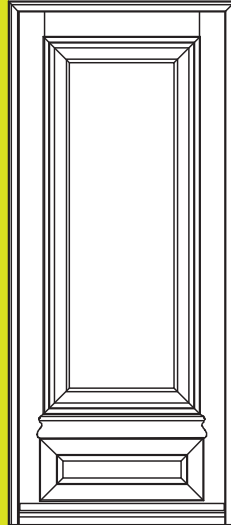

DOOR WITH "VERSAILLES"
PANEL AT BOTTOM

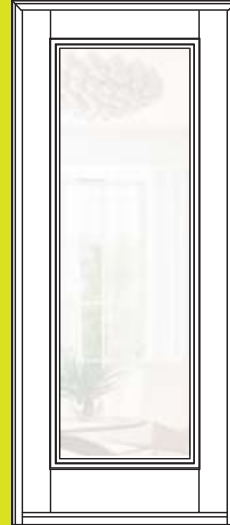

GLASS DOOR
TYPE "A" MOLDING

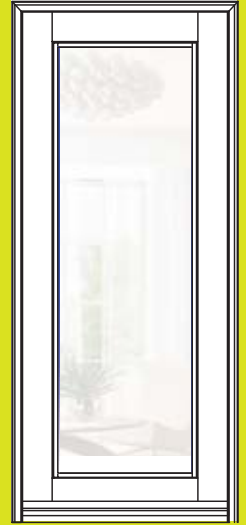

MODERN DOOR
LARGE FRAME
GLASS OR FLAT PANEL

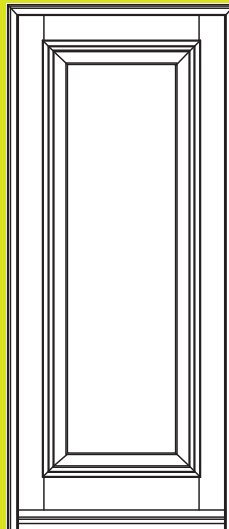

MODEL 1-1

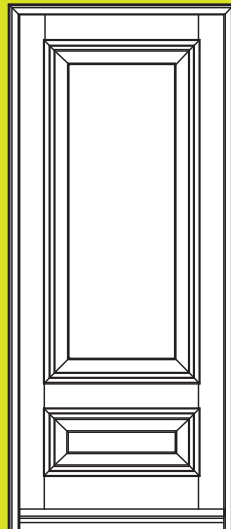

MODEL 11-51

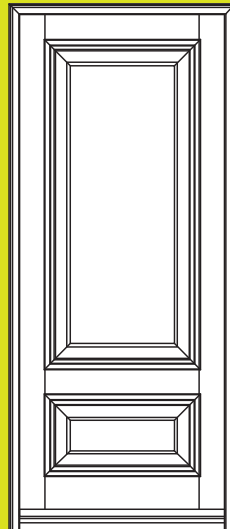

MODEL 11-41

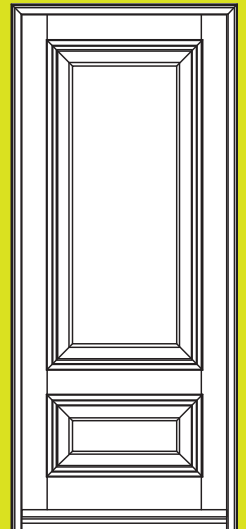

MODEL 11-31



NUMEROUS MOLDING OPTIONS

Solid panels can be substituted with glass.

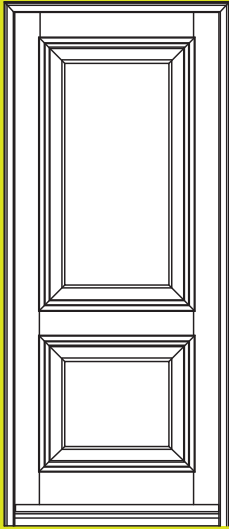

MODEL 11-21

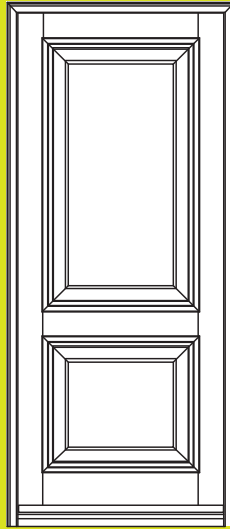

MODEL 11-11

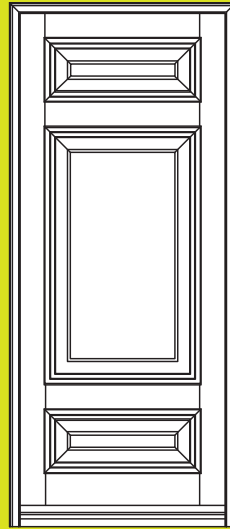

MODEL 111-141

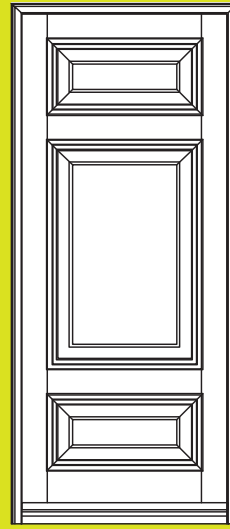

MODEL 111-131

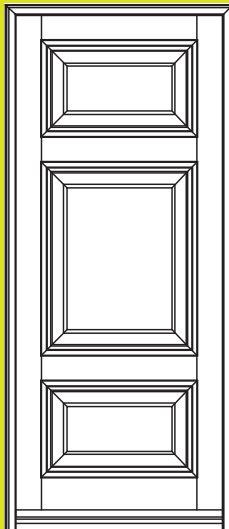

MODEL 111-121

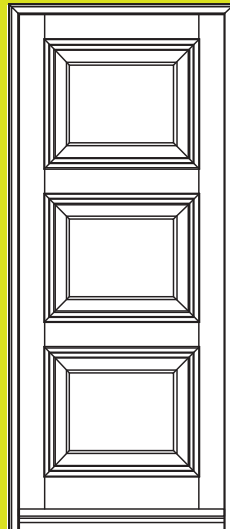

MODEL 111-111

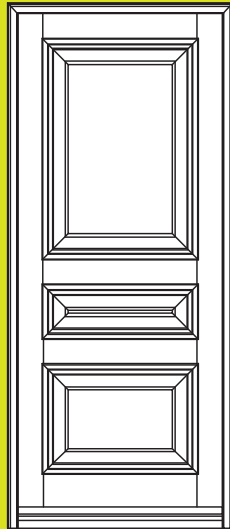

MODEL 111-412

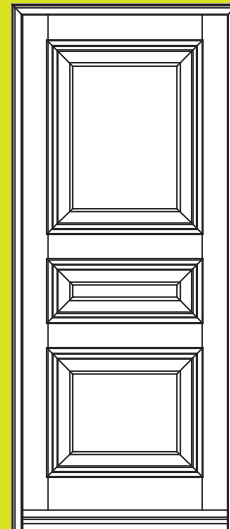

MODEL 111-312

MODELS



VARIOUS TRANSOM OPTIONS

TRANSOMS

Curved transom (available products)

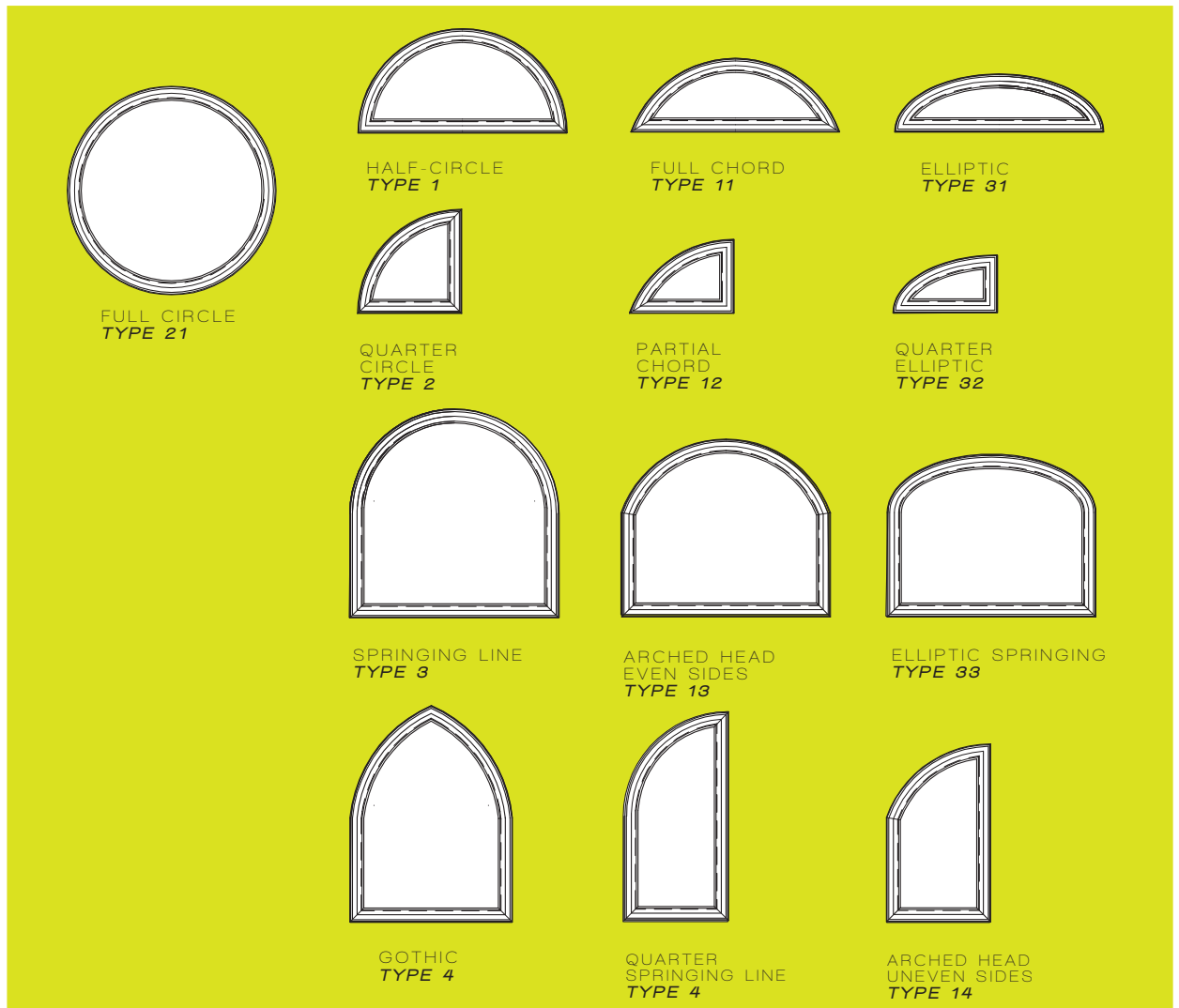

Angle transoms (available products)

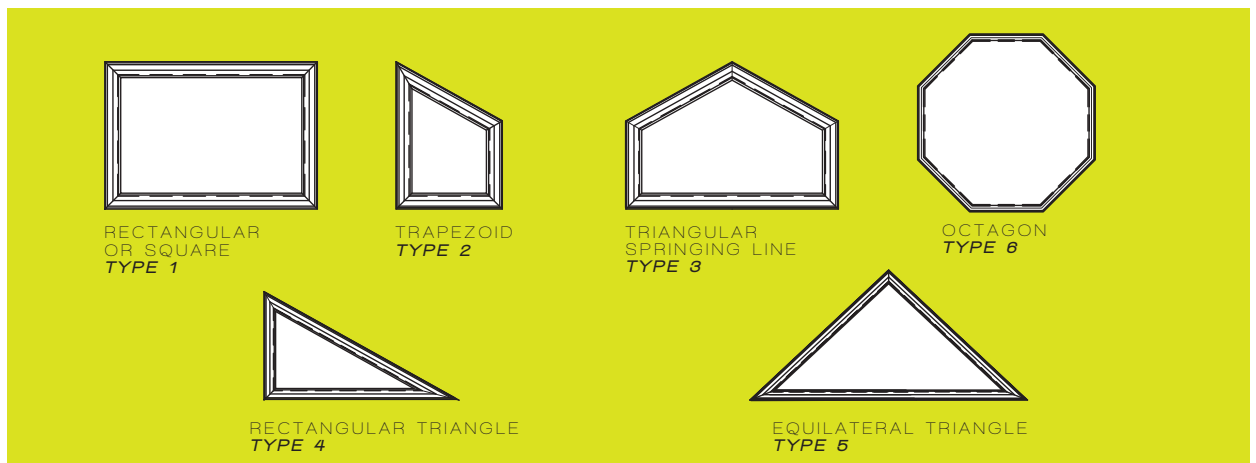

Allow your imagination to combine various available elements. You can integrate arched shapes or rectangular shapes. The mullions are constructed to the narrowest width for maximum light.



TECHNICAL DETAILS

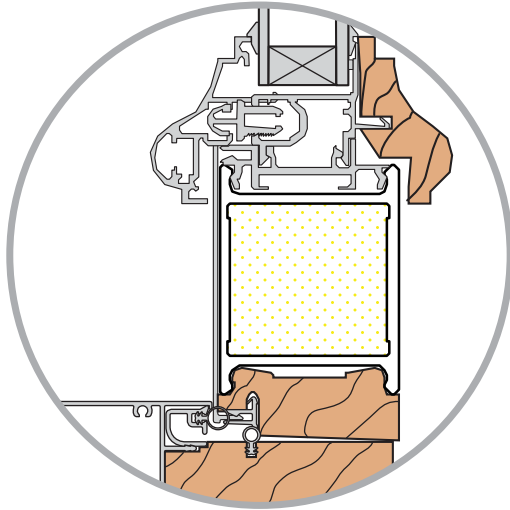

Narrow frame (glass garden door)
Traditional type molding

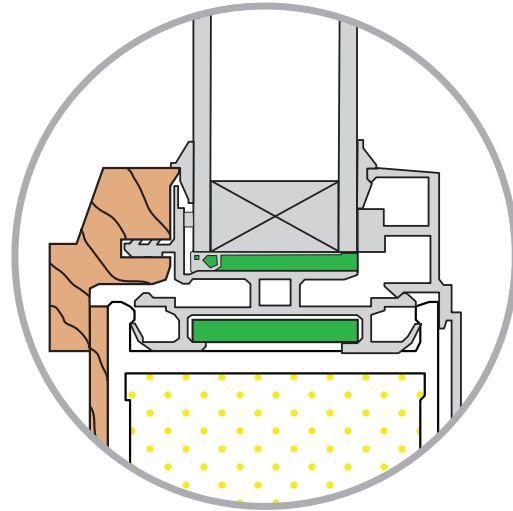

Narrow frame (glass garden door)
Modern type molding

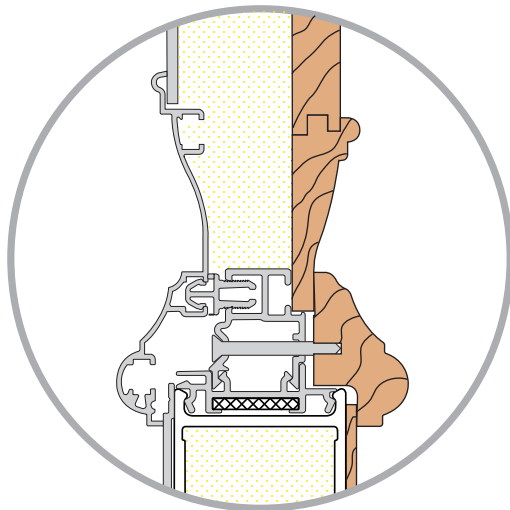

"A" molding traditional panel

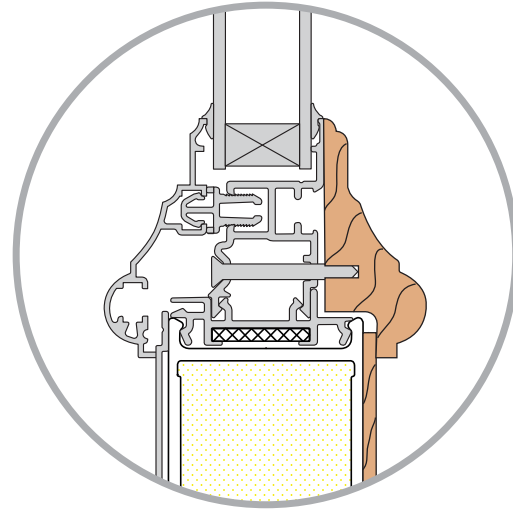

"AT" molding traditional glass

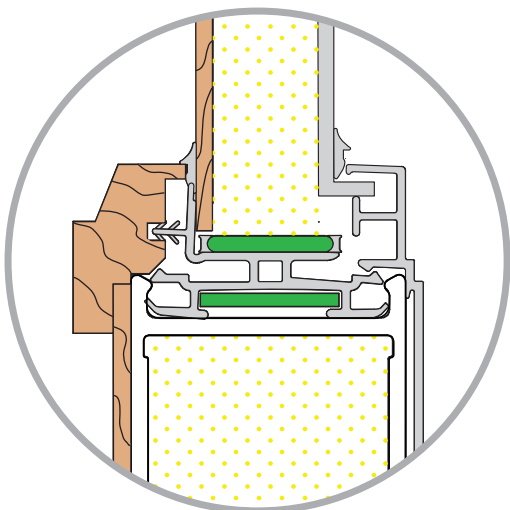

Modern type molding
Glass or panel

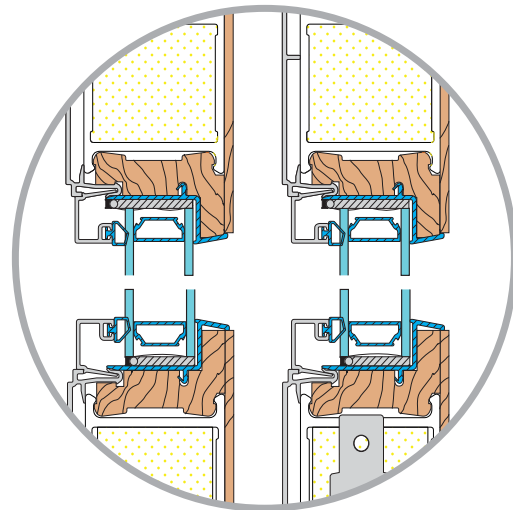

Lift and slide door



TECHNICAL DETAILS

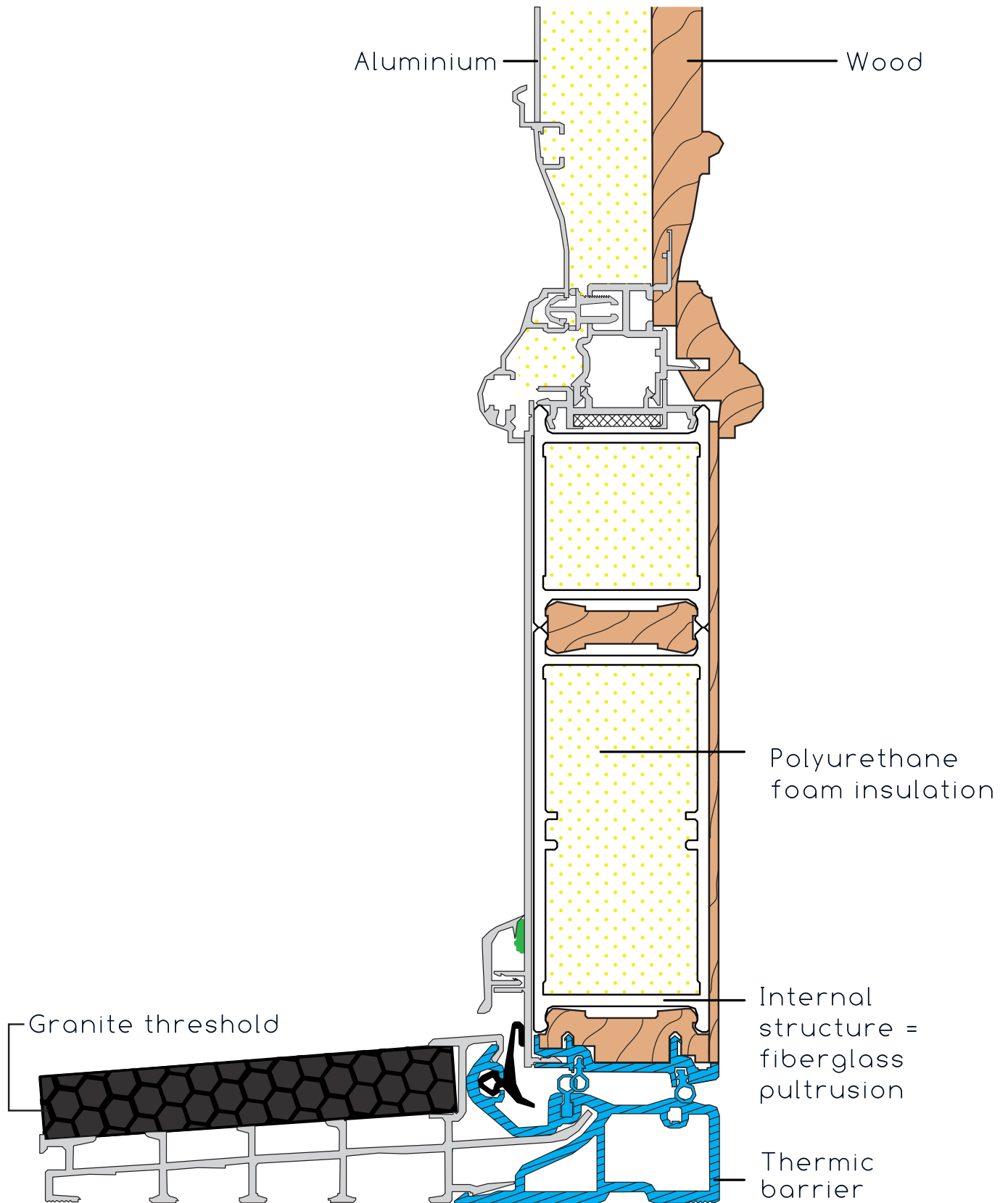



TECHNICAL DETAILS

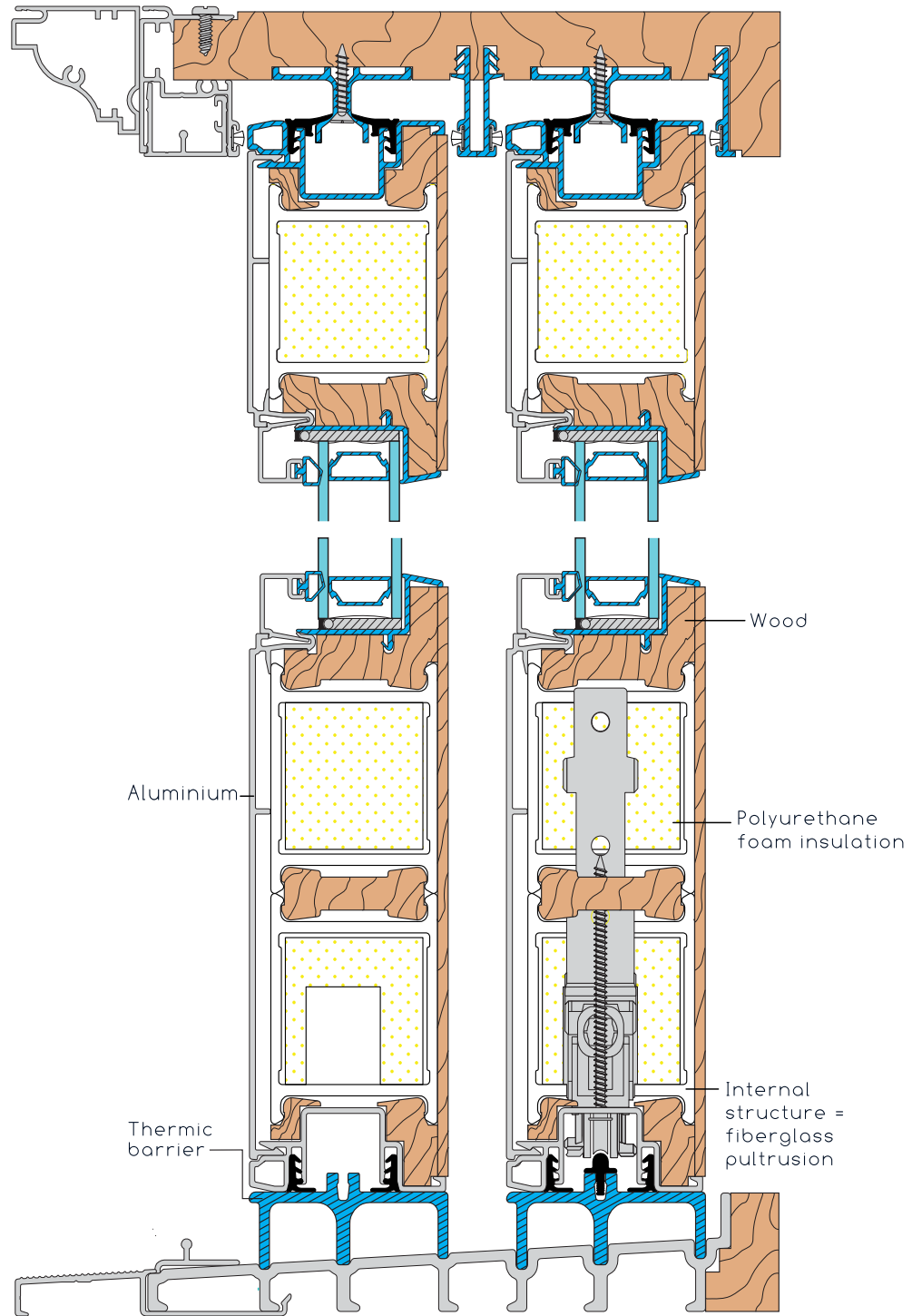

POSSIBILITY OF MANY PANELS

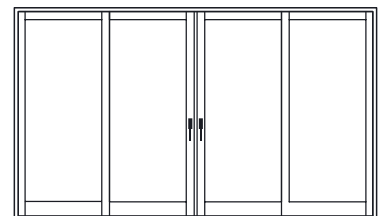
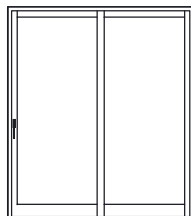



NUMEROUS MOLDING OPTIONS

Solid panels can be substituted with glass.

MODELS

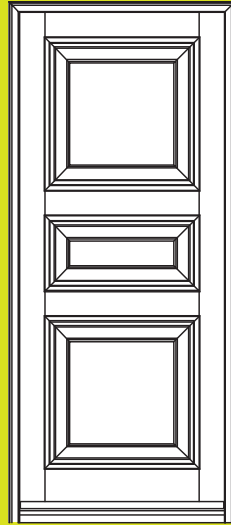

MODEL 111-212

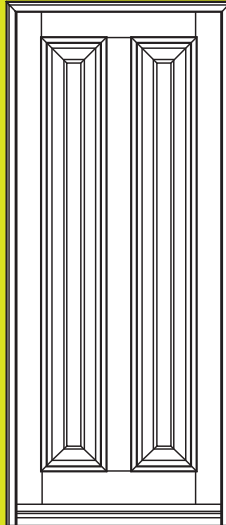

MODEL 2-1

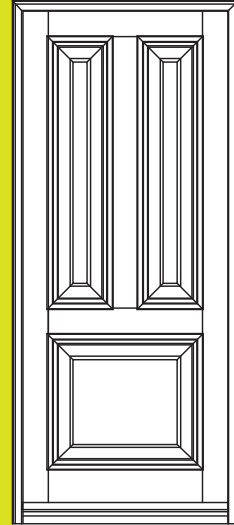

MODEL 21-21

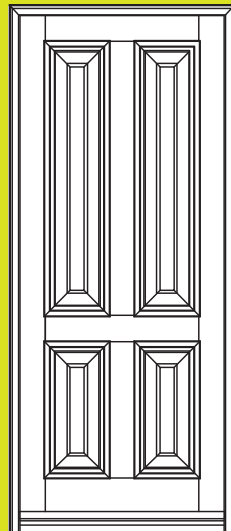

MODEL 22-21

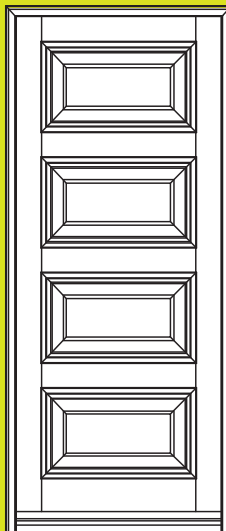

MODEL 1111-1111

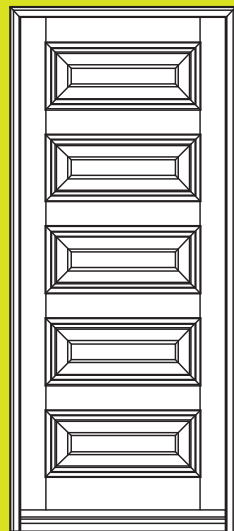

MODEL 11111-11111



NUMEROUS MOLDING OPTIONS

Solid panels can be substituted with glass.

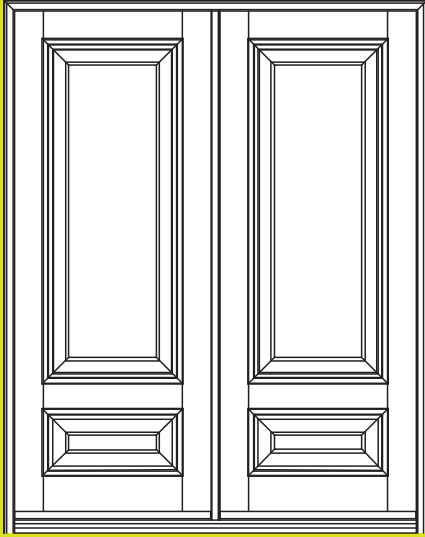

DOUBLE DOORS MODEL 11-51

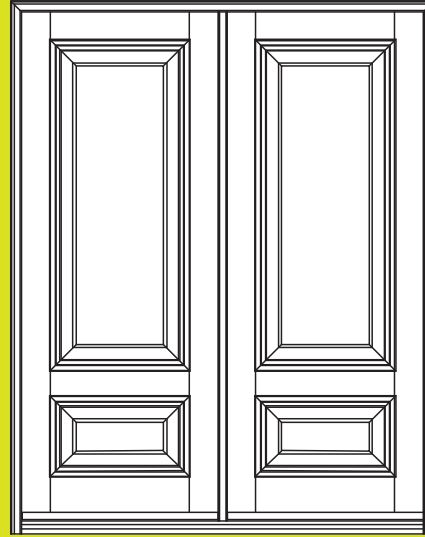

DOUBLE DOORS MODEL 11-41

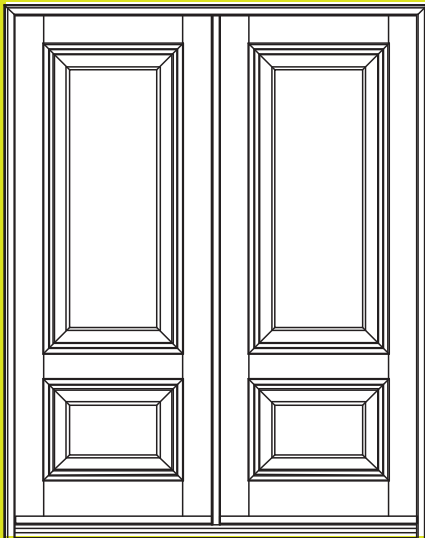

DOUBLE DOORS MODEL 11-31

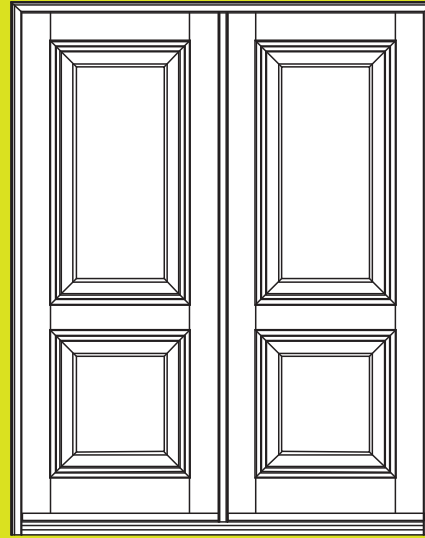

DOUBLE DOORS MODEL 11-21

MODELS



NUMEROUS MOLDING OPTIONS

Solid panels can be substituted with glass.

MODELS

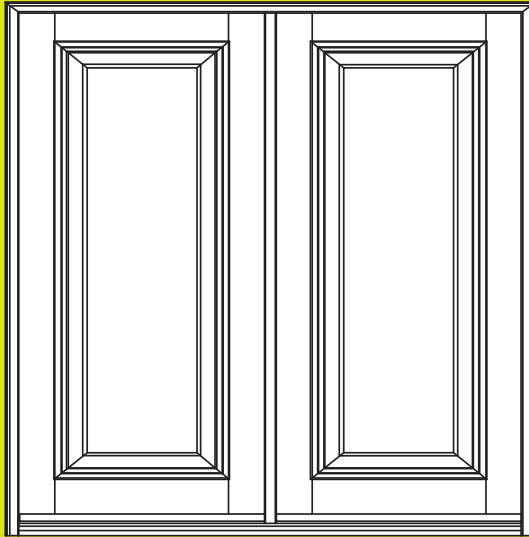

DOUBLE DOORS MODEL 1-1

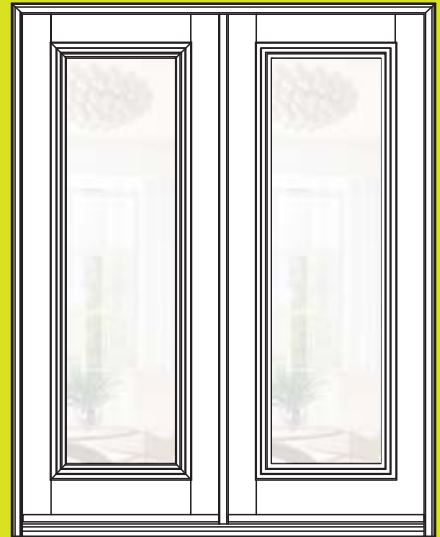

DOUBLE GLASS DOORS
LARGE FRAME

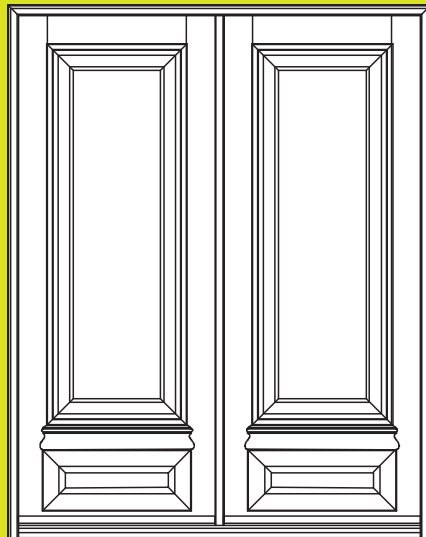

NOTCH DOUBLE DOORS
LARGE FRAME

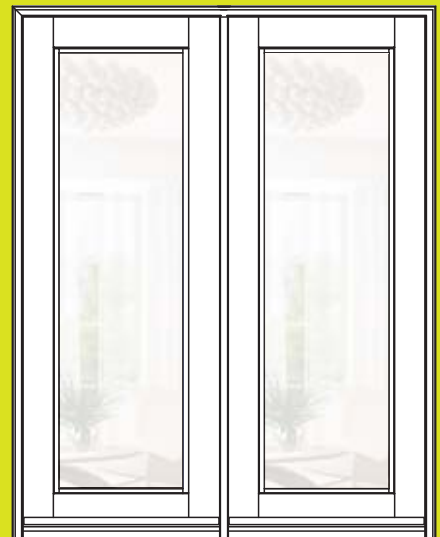

MODERN DOORS LARGE FRAME
GLASS OR FLAT PANEL



NUMEROUS MOLDING OPTIONS

Solid panels can be substituted with glass.

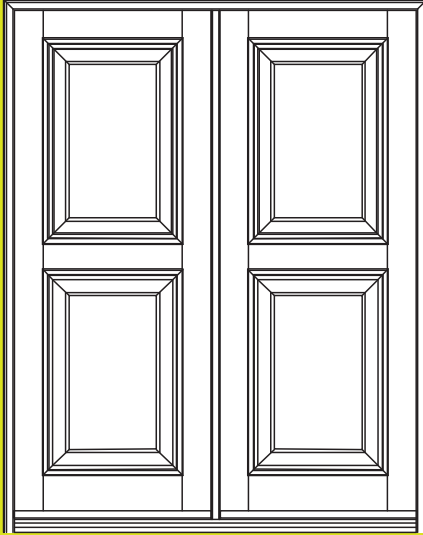

DOUBLE DOORS MODEL 11-11

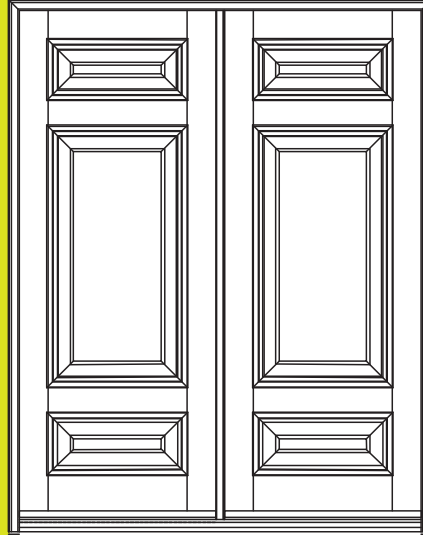

DOUBLE DOORS MODEL 111-141

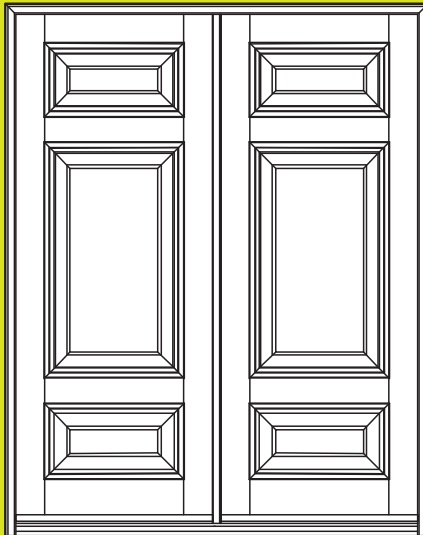

DOUBLE DOORS MODEL 111-131

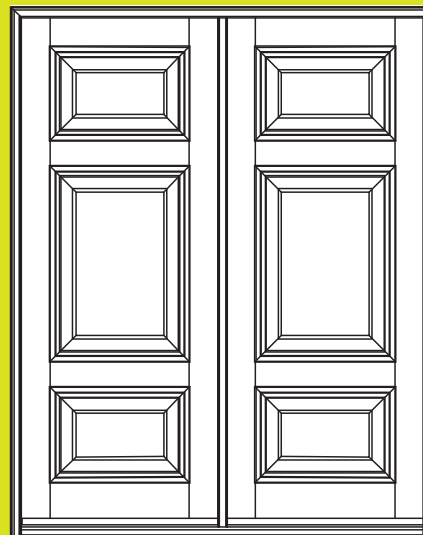

DOUBLE DOORS MODEL 111-121

MODELS



NUMEROUS MOLDING OPTIONS

Solid panels can be substituted with glass.

MODELS

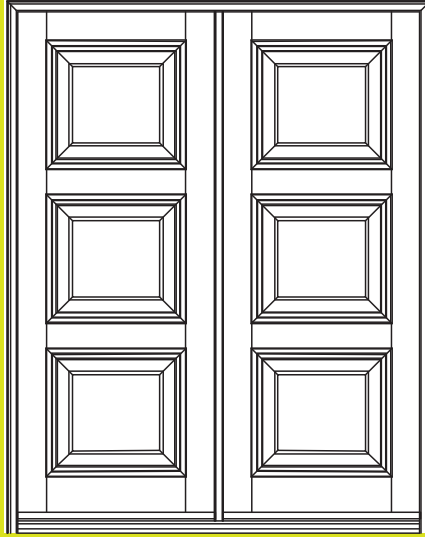

DOUBLE DOORS MODEL 111-111

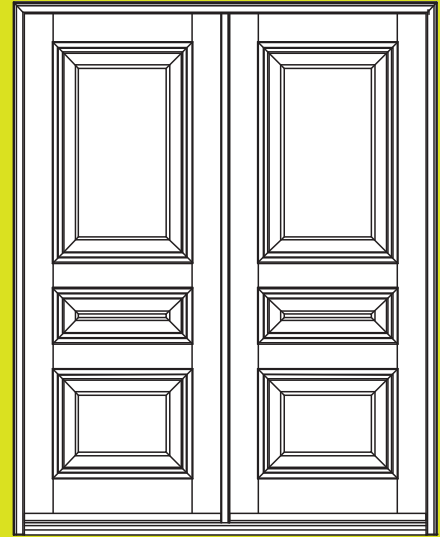

DOUBLE DOORS MODEL 111-412

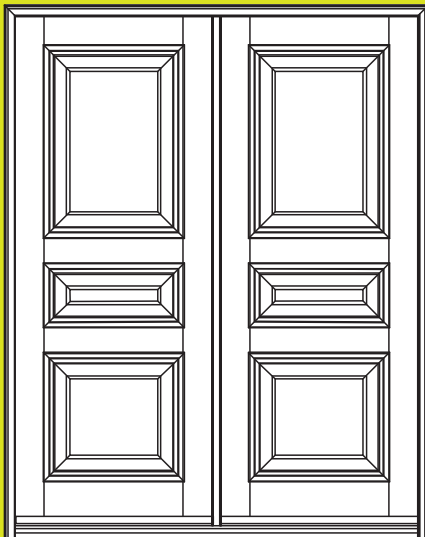

DOUBLE DOORS MODEL 111-312

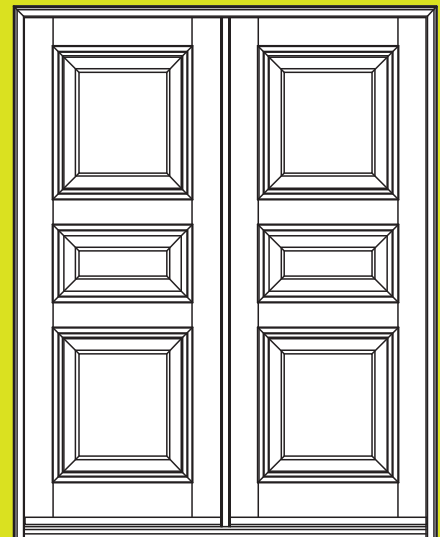

DOUBLE DOORS MODEL 111-212



NUMEROUS MOLDING OPTIONS

Solid panels can be substituted with glass.

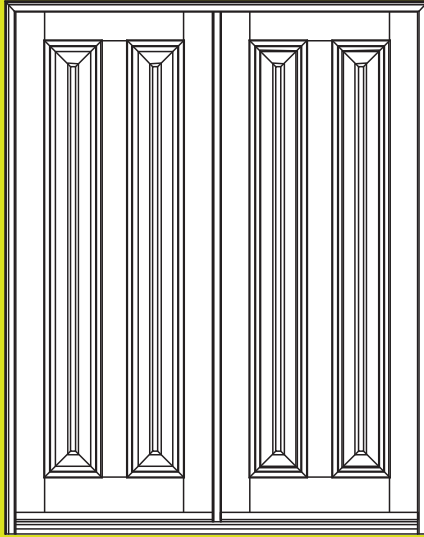

DOUBLE DOORS MODEL 2-1

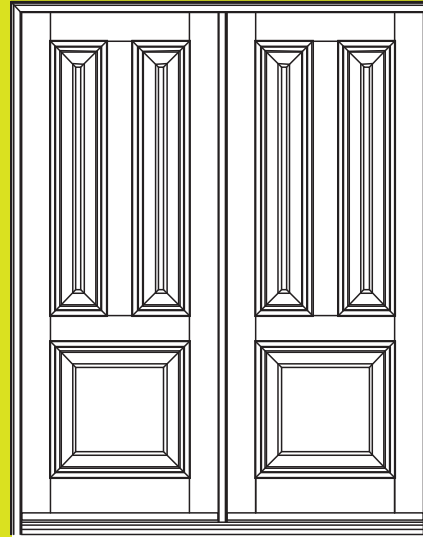

DOUBLE DOORS MODEL 21-21

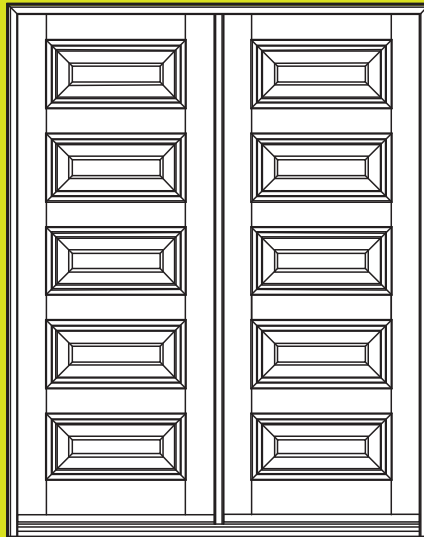

DOUBLE DOORS MODEL 11111-11111

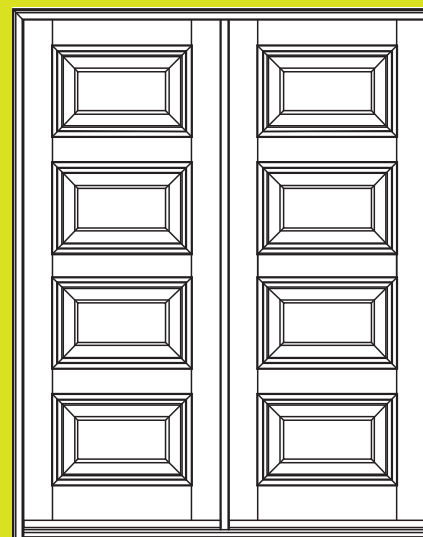

DOUBLE DOORS MODEL 1111-1111

MODELS



MARCHAND LIMITED WARRANTY

Quality tested and certified

Quality is the basis of our products

Processing is conceived to last, our installation techniques and our service after-sales are reliable and we warrant all products which is our trademark.

Our warranty includes product testing, permanent internal controls and a follow-up on installation.

Reliable operation and quality products without concession.

Marchand is proud to offer a seven (7) year limited warranty on ELEGANCE base products:

- Structure
- Opening and closing mechanism
- Wood laminate
- Paint powder

A ten (10) year warranty on thermos.

In regards to wood finished surface, Marchand warranty is seven (7) years against peeling and cracking. However, any warranty will not apply in the event that wood has been exposed to an abnormally high humidity.

NOTES



MARCHAND

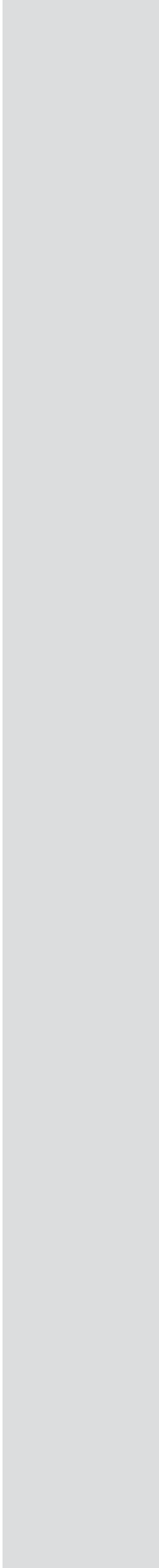



#RBQ:8105-4678-00



FACTORY | 165 Lamarche Ave. , Ste-Catherine, (Quebec), J5C 1Z8